

CONSTRUCTION	ROTATION	DISCH PORT
HORIZONTAL LEFT	CLOCKWISE (CW)	TOP SIDE
	COUNTERCLOCKWISE (CCW)	BOTTOM SIDE
HORIZONTAL RIGHT	CLOCKWISE (CW)	BOTTOM SIDE
	COUNTERCLOCKWISE (CCW)	TOP SIDE

ESTIMATED WEIGHT - 1100 LBS

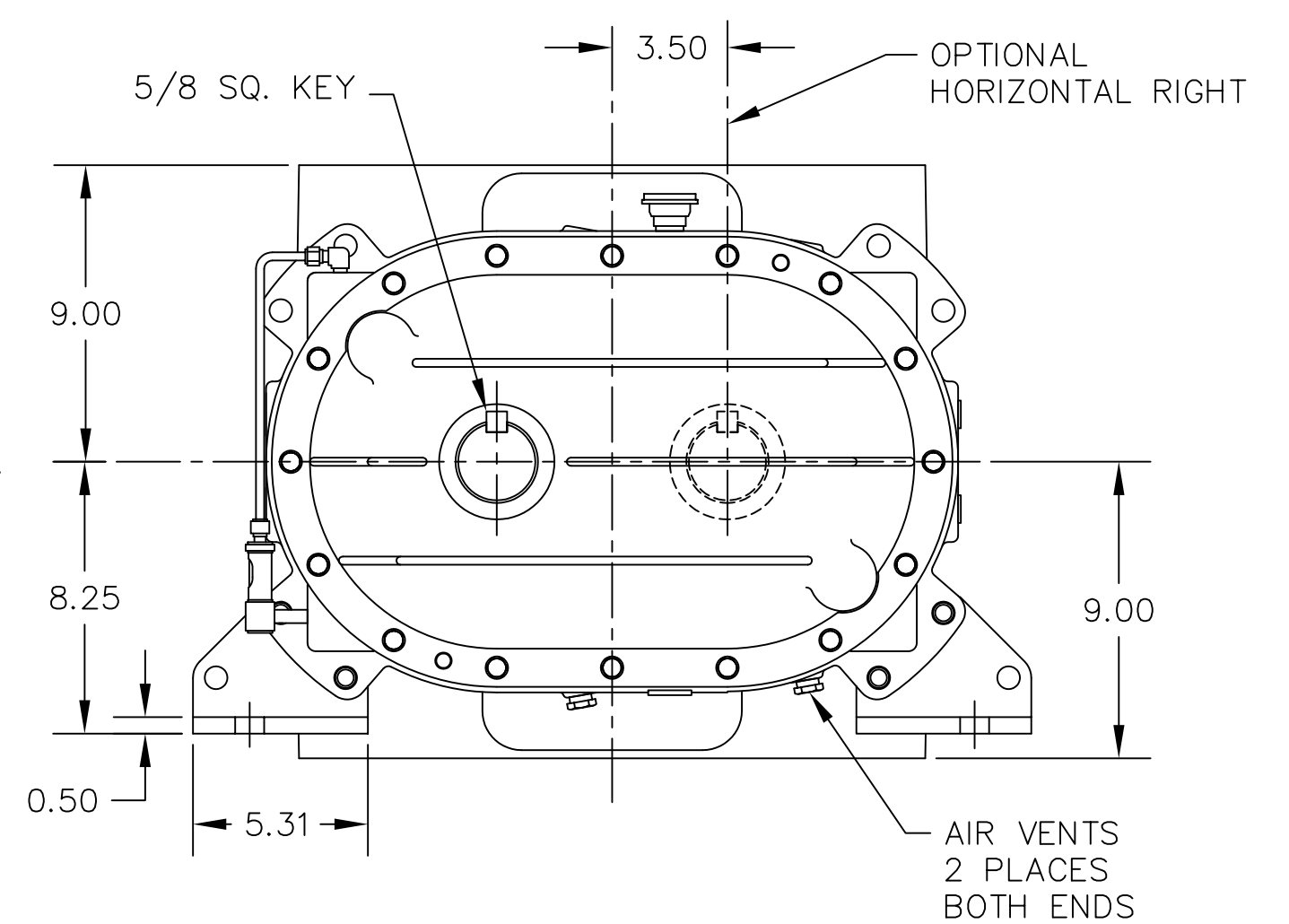
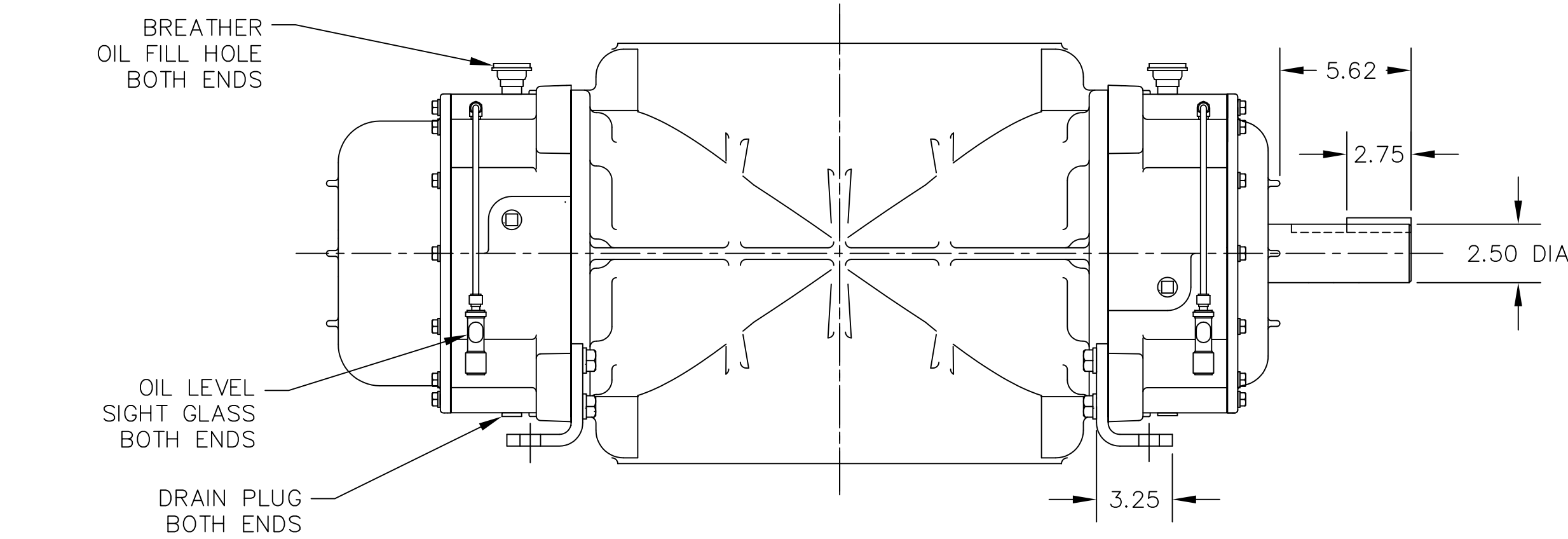

CONFIDENTIAL - THE INFORMATION CONTAINED IN THIS DOCUMENT IS THE PROPERTY OF GARDNER DENVER MACHINERY INC. IT IS NOT FOR PUBLIC DISCLOSURE. POSSESSION OF THE INFORMATION DOES NOT CONVEY ANY RIGHT TO LOAN, SELL OR DISCLOSE THE INFORMATION. UNAUTHORIZED REPRODUCTION OR USE OF THE INFORMATION IS PROHIBITED. THIS DOCUMENT IS TO BE RETURNED TO GARDNER DENVER MACHINERY INC. UPON COMPLETION OF THE PURPOSE FOR WHICH IT IS LOANED OR UPON REQUEST.

TAP DRILL DEPTHS ARE MAXIMUM. FULL THD. DEPTHS ARE MINIMUM.

FINISH OF CHAMFERS & FILLETS TO CONFORM TO ROUGHEST ADJACENT AREA

SURFACE ROUGHNESS MAX. PER ASA SPEC.

LET.	REVISION	DATE	DR.	CK.	LET.	REVISION	DATE	DR.	CK.	LET.	REVISION	DATE	DR.	CK.
A	RELEASED (C/M 1028500)													

Gardner Denver
 Gardner Denver Inc.
 Peachtree City, Georgia

TOLERANCES: UNLESS OTHERWISE SPECIFIED
 DECIMAL .XX ± .02 .XXX ± .010
 NON-DECIMAL ± 1/16 ANGLES ± 1°

HEAT TREAT SPEC. -

SHEET 1 OF 1

FOR ALL CURRENT SPECIFICATIONS REFER TO BILL OF MATERIAL

NAME: OUTLINE-BARE UNIT
 7023 DUROFLOW HORIZONTAL

DR.	SLM	11/22/05	MET. APP.
CK.	SM	11/22/05	ENG. APP.

SCALE: 3/16

308GGG800

FILE NO. C CAD/CAM